

PREFORMED ELASTOMERIC JOINT SEAL SHALL BE D.S. BROWN E-686 OR EQUIVALENT.

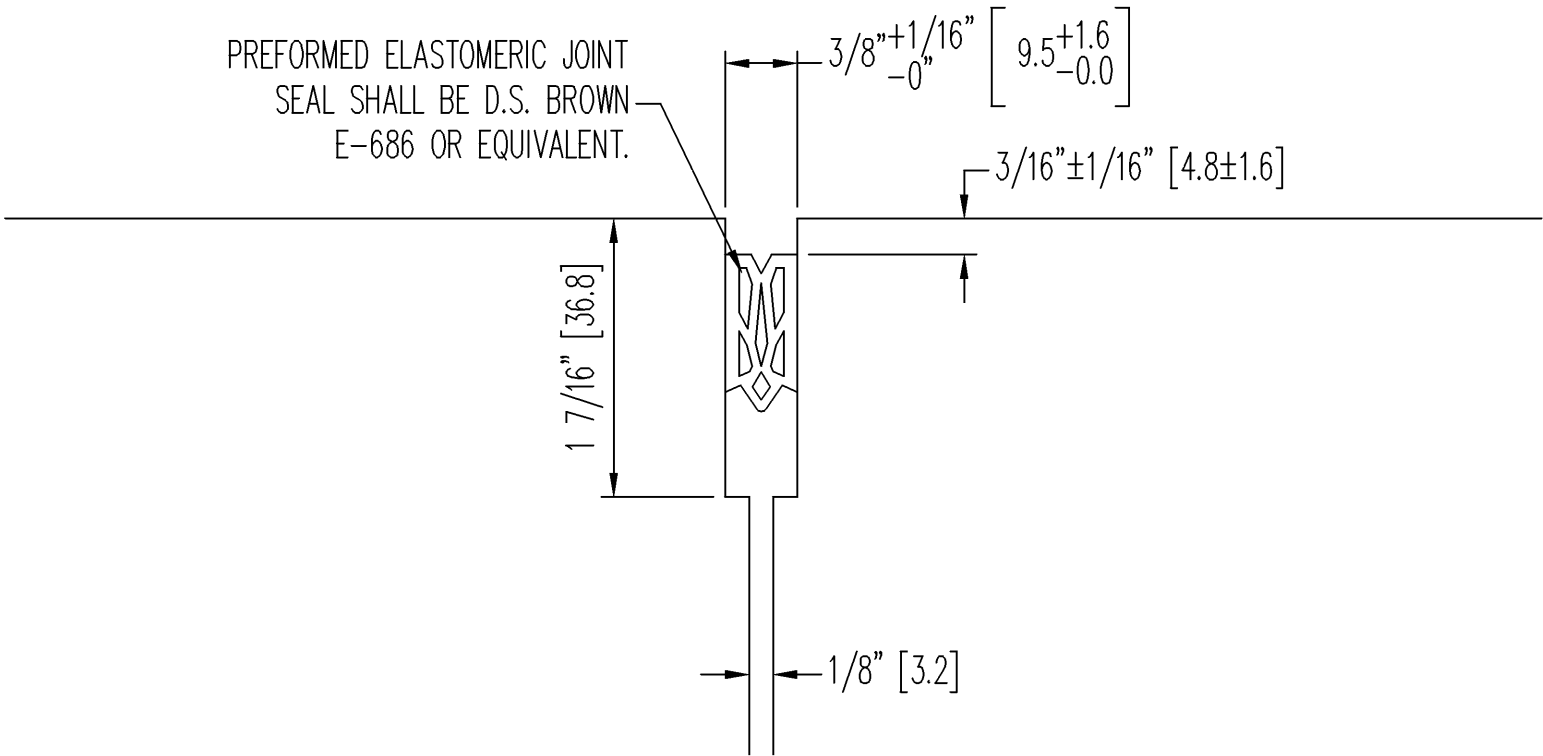

CONTRACTION JOINT SEAL DETAIL
E-686 COMPRESSION SEAL



SCALE: N.T.S.	DRAWN BY: A.B.	CHECKED BY:	DATE: 12-14-95	REV. DATE 03-08-03
FOLDER: SEAL\COMPRESSION-SEAL\E			REVISION: 1	SHEET E686-JO